



COD	MEDIDA	HEX	ALT
21-001	1-1/4-12	2-1/4	1"
21-001-A	1-3/8-12	2-1/4	1"
21-021-A	1-1/8-12	1-5/8	1"

Aplicación			
Tuerca de arado kimball			



COD	MEDIDA	HEX	ALT
21-004	1-1/4-12	1-3/4	3/4

Aplicación			
Tuerca para Mango Massey Ferguson			



COD	MEDIDA	HEX	ALT
21-002	1-3/8-12	1-3/4	1-3/8

Aplicación			
Tuerca Para Rastra De John Deree			

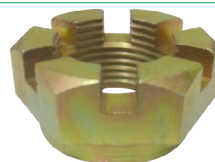

COD	MEDIDA	HEX	ALTURA
21-005	1"-14	1-1/2	3/4
21-014	1-1/2"12	2-1/4	1-1/4
21-307	1-1/8"-12	1-5/8	7/8

Aplicación			
Tuerca Para Arado Internacional			



COD	MEDIDA	HEX	ALT
21-003	1-1/2-12	2-1/4	13/16
21-021	1-5/8-12	2-1/2	1"
21-022	1-3/4-12	2-3/4	1"
21-023	1-7/8-12	2-3/4	1"
21-024	2"-12	2-3/4	1"

Aplicación			
Tuerca Para Rastra John Deree y Americano			



COD	MEDIDA	Diametro	ALT
21-006	1.320mm	2-1/4	9mm

Aplicación			
Ronadana Para Tuerca Arado Internacional			

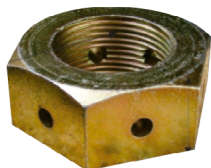

COD	MEDIDA	HEX	ALT
21-003-A	1-1/2-12	2-1/4	1"

Aplicación			
Tuerca Para Rastra Tipo Americano			



CODIGO	MEDIDA	DESCRIPCION
21-300	1"14	JUEGO DE ARADO INTERNACIONAL
21-308	1-1/8"-12	JUEGO DE ARADO INTERNACIONAL





COD	MEDIDA	HEX	ALTURA
21-309	1"-14	1-1/2	3/4
Aplicación			
Ronadana Para Tuerca Arado Internacional			

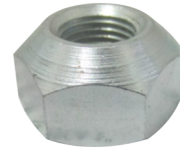

COD	MEDIDA	HEX	ALT
AG-01 21-009	1/2-20	1-1/16	9/16
Aplicación			
Rueda Delantera Massey Ferguson y Ford			



COD	Medida INT	HEX	ALT
21-007	3-4-16	1-1/4	1-3/8
Aplicación			
Capuchon para eje de Massey Ferguson			



COD	MEDIDA	HEX	ALT
21-010	9/16-18	1-1/16	7/8
21-011	5/8-18	1-1/8	1"
21-019	11/16-16	1-1/16	1"
Aplicación			
Rueda Trasera Massey Ferguson 135 y 165			



COD	MEDIDA	HEX	ALT
21-007-A	3/4-16"	1-1/4"	1-3/8
21-028	3/4-10"	1-1/4"	7/8"
Aplicación			
Tuercas P/ Clutch y Capuchon Massey			



COD	MEDIDA	HEX	ALT
AG-04 21-012	3/4-16	1-1/2	7/8
AG-04 "L"	3/4-16	1-1/2	7/8
Aplicación			
Rueda Trasera Camion Dodge Y Ford			

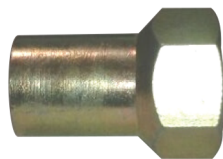

COD	MEDIDA	HEX	ALT
21-112-A	5/8-18"	1-1/16"	1-3/8
21-112-B	3/4-16"	1-1/4"	1-3/8
21-113	11/16-16	1-1/4"	1-3/8
Aplicación			
TUERCAS PARA CAPUCHON			



COD	MEDIDA	HEX	ALT
21-013	11/16-20	1-1/16	9/16
Aplicación			
Tuerca Ins. Para Volante De Direccion Ford			





COD	INTERIOR	HEX.	ALTURA
21-180	18 x 1.5	27mm	21mm
Aplicación			
TUERCA DE CAMPANA PAR TRACTOR			



COD	MEDIDA	HEX	ALT
21-008	3/4-16	1-1/4	5/8
Aplicación			
Tuerca Para Mango Massey Ferguson			

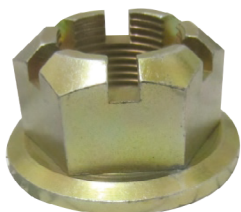

COD	MEDIDA	HEX	ALT	ROND.
21-030	1-1/4-12	1-3/4	1-3/8	2-3/16
21-030-A	1"-14	1-1/2	1-3/8	2-3/16
Aplicación				
Tuerca Castillo con Rondana Agrícola				



COD	MEDIDA	LARGO
21-020	9/16-18	4"
Aplicación		
Birlo de Flecha Base de caja Massey Ferguson		

Chavetas De Aro



COD	MEDIDA
21-234	3/16"
CH-01 21-234	1/4"
CH-02 21-134	5/16"
CH-03 21-133	3/8"
21-192	7/16"

Chavetas Agrícolas Tipo "R"



COD	MEDIDA
21-193	1/16"
PA-437 21-179	1/8"
PA-439 21-129	3/16"
PA-440 21-130	1/4"
PA-441 21-131	5/16"
PA-442 21-163	3/8"
21-195	7/16"

Rondanas Agrícolas

21-029



DESCRIPCION: RONDANA PARA TORNILLO DE CHUPON

INTERIOR	3/4"
EXTERIOR	2-1/4"
ALTURA	5/16"

21-311



DESCRIPCION: RONDANA PARA TORNILLO MACHETE

INTERIOR	1-3/8"
EXTERIOR	2-1/4"
ALTURA	3/16"

21-313



DESCRIPCION: RONDANA PARA TORNILLO MACHETE

INTERIOR	1-1/2"
EXTERIOR	2-1/4"
ALTURA	3/16"

21-312

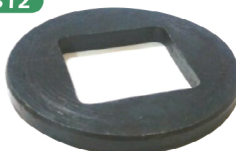

DESCRIPCION: RONDANA PARA TORNILLO MACHETE

CUADRO	1-1/8"
EXTERIOR	2-1/4"
ALTURA	3/16"

21-314



DESCRIPCION: RONDANA PARA TORNILLO MACHETE

CUADRO	1-1/16"
EXTERIOR	2-1/4"
ALTURA	3/16"



21-301

2 Eslabones

Cacahuete azul

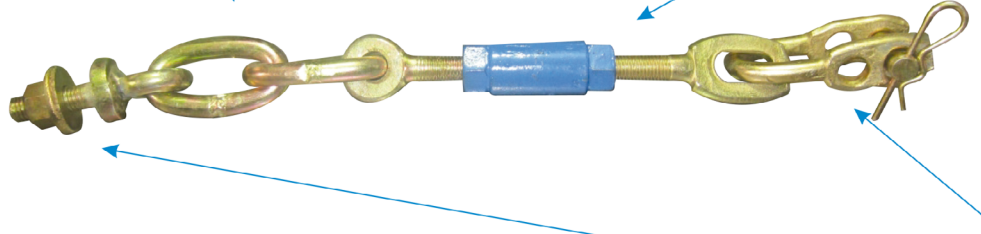

Cadena estabilizadora c/ Chupon y horquilla Doble
P/tractor Ford 500

H-401

21-301-L

Chupon

2 Eslabones



21-301-R

punta de armella y horquilla Doble



21-302

3 Eslabones

Cacahuete azul

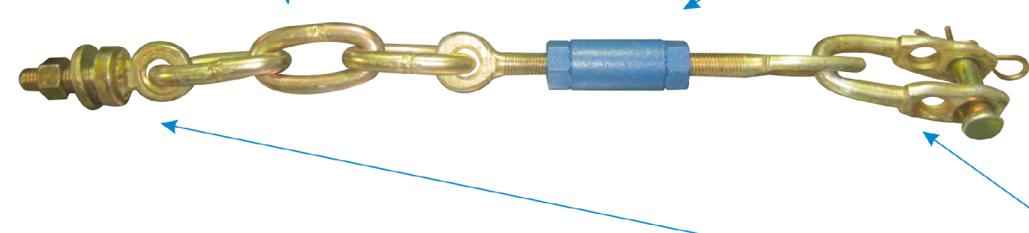

Cadena estabilizadora c/ Chupon y horquilla Doble
P/tractor Ford 500

H-402

21-302-L

Chupon

3 Eslabones

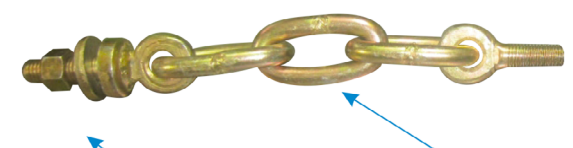

21-301-R

Terminal Argolla y horquilla Doble



Precio pendiente



Cacahuete rojo

21-303

4 Eslabones

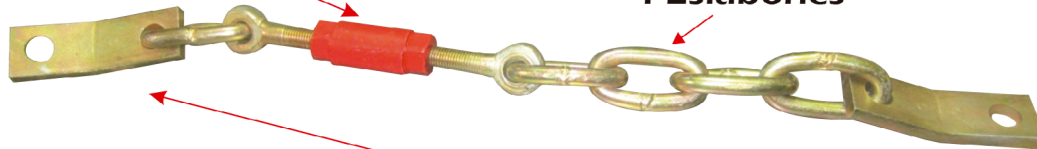

Cadena estabilizadora 2 placas
P/tractor Masey Ferguson

H-404



21-303-R

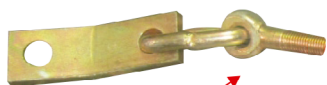

Tornillo Armella y Placa



21-303-L

4 Eslabones



Tornillo Armella y Placa



Cacahuete rojo

21-304

4 Eslabones



Cadena estabilizadora c/horquilla y placa
P/ Tractor Masey Ferguson

H-405



21-304-R



Horquilla y tornillo de ojo





21-305

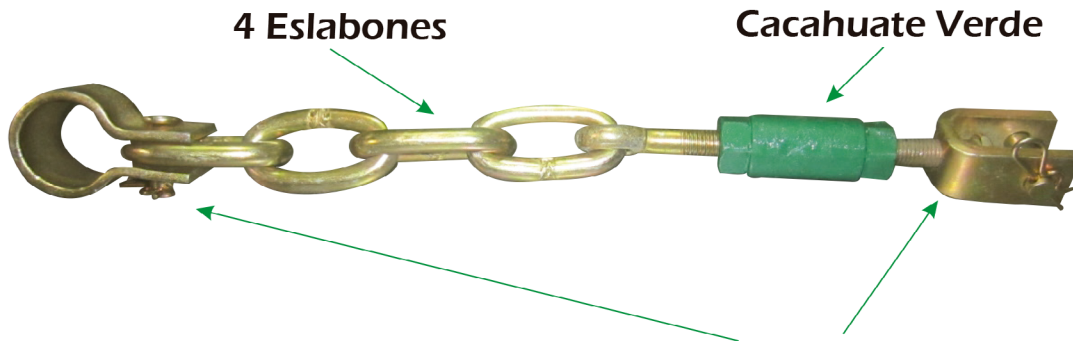

H-406

Cadena estabilizadora Doble horquilla



21-305-R

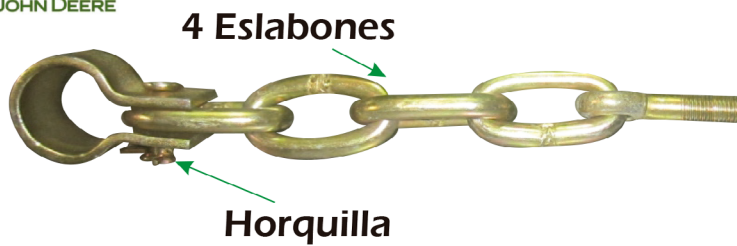

21-305-L



Horquilla Completa P/ Jhon Deere



21-306

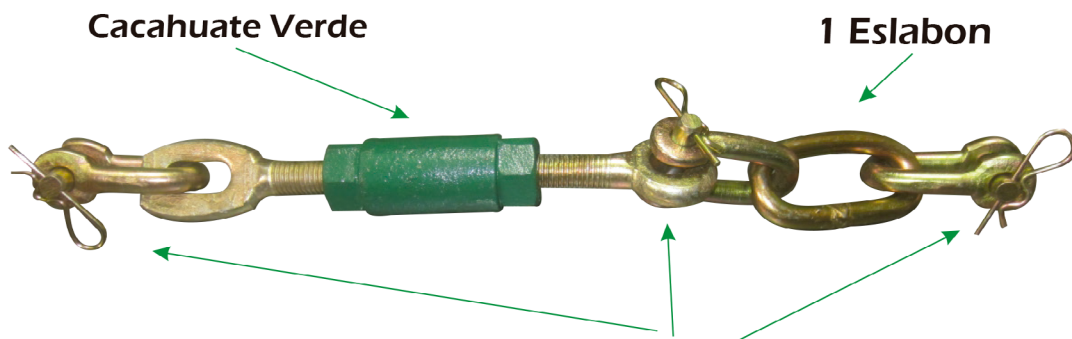

H-407

Cadena estabilizadora 3 horquillas tipo TURBO



21-306-R



21-306-L

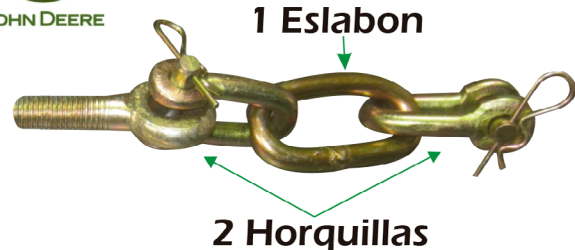



COD	ALTO	ANCHO	LARGO
21-058	1/2"	1"	6"

Aplicación
PLACA PARA CADENA ESTABILIZADORA UNIV.

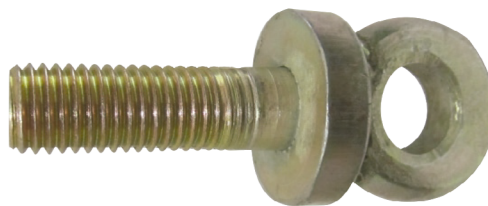

COD	ROSCA	LARGO
21-127	3/4"-10	4-1/2"

Aplicación
Tornillo Chupon P/Cadena Ford F5000/F6600



COD	ROSCA	LARGO
21-075-R	3/4"-10	6"
21-075-L	3/4"-10	6"

Aplicación
Terminal de Argolla Ovalada para cadena J.D.



COD	DESCRIPCION
21-128	ESLABON DE CADENA 1/2"
21-128-A	ESLABON DE CADENA 5/8"



COD	Aplicación
21-087	Orquilla para cadena Universal



COD	DESCRIPCION
21-157	ORQUILLA P/ CADENA ESTAB FORD



COD	Aplicación
21-088	Orquilla Der. Para Cadena J.D.



COD	DESCRIPCION
21-168	ORQUILLA PARA CADENA M.F.





COD	DESCRIPCION
21-169	ORQUILLA DOBLE P/ CADENA M.F.



COD	ROSCA	LARGO
21-154	3/4"-10	3"
Descripción		
Terminal Estabilizadora. J.D.		



COD	MEDIDA	HEX	LARGO
21-015-A	3/4-10	1-1/4	4" ●
21-015-B	3/4-10	1-1/4	4" ●
21-015-C	3/4-10	1-1/4	4" ●

Aplicación			
Cacahuate para templador de Cadena Agrícola			

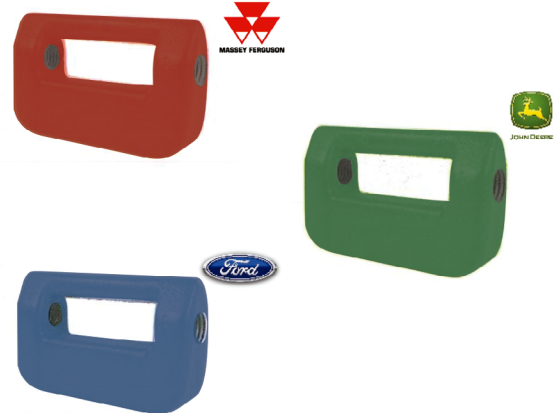

COD	MEDIDA	TIPO	Color
21-225-A	3/4-10	Manopla	●
21-225-B	3/4-10	Manopla	●
21-225-C	3/4-10	Manopla	●

Aplicación	
Cacahuate para templador Tipo Manopla	

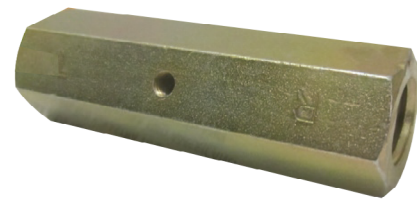

COD	MEDIDA	HEX	LARGO
CH-11 21-015	3/4-10	1-1/8	100mm
CH-12 21-015	7/8-9	1-1/4	100mm
CH-13 21-015	1"-8	1-1/2	100mm

Aplicación	
Cacahuate para templador de Cadena	



CODIGO	MEDIDA	DESCRIPCION
21-216-FLE	16x2	TENSOR PARA CADENA J.D.



Pernos lisos Agrícolas

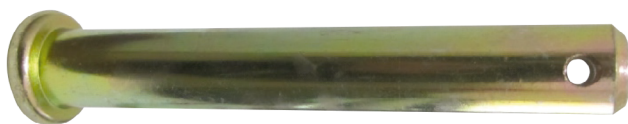

CODIGO	DIAMETRO	LARGO
21-315	1/4"	1"
21-316	1/4"	1-1/2"
21-317	1/4"	2"

CODIGO	DIAMETRO	LARGO
21-318	5/16"	1"
21-319	5/16"	1-1/2"
21-320	5/16"	2"

CODIGO	DIAMETRO	LARGO
21-321	3/8"	1"
21-322	3/8"	1-1/4"
21-323	3/8"	1-1/2"
21-324	3/8"	2"

CODIGO	DIAMETRO	LARGO
21-325	7/16"	1-1/4"
21-326	7/16"	1-1/2"
21-327	7/16"	2"

CODIGO	DIAMETRO	LARGO
21-328	1/2"	1"
21-329	1/2"	1-1/2"
21-330	1/2"	1-3/4"
21-331	1/2"	2"
21-332	1/2"	2-1/2"
21-333	1/2"	2-1/4"
21-334	1/2"	3"
21-335	1/2"	7"

CODIGO	DIAMETRO	LARGO
21-336	9/16"	1-3/4"
21-337	9/16"	2"

CODIGO	DIAMETRO	LARGO
21-338	5/8"	2"
21-339	5/8"	2-1/2"
21-340	5/8"	2-1/4"
21-341	5/8"	3"
21-342	5/8"	3-1/2"
21-343	5/8"	4"
21-344	5/8"	4-1/2"
21-345	5/8"	5"
21-346	5/8"	5-1/2"
21-347	5/8"	6"
21-348	5/8"	6-1/2"
21-349	5/8"	7"

CODIGO	DIAMETRO	LARGO
21-350	3/4"	2"
21-351	3/4"	2-1/2"
21-352	3/4"	2-3/4"
21-353	3/4"	2-7/8"
21-354	3/4"	3"
21-355	3/4"	3-1/2"
21-356	3/4"	4"
21-357	3/4"	4-1/2"
21-358	3/4"	5"
21-359	3/4"	5-1/2"
21-360	3/4"	6"
21-361	3/4"	6-1/2"
21-362	3/4"	7"
21-363	3/4"	8"

CODIGO	DIAMETRO	LARGO
21-364	7/8"	3"
21-365	7/8"	3-1/4"
21-366	7/8"	3-1/2"
21-367	7/8"	4"
21-368	7/8"	4-1/2"
21-369	7/8"	5"
21-370	7/8"	5-1/2"
21-371	7/8"	6"
21-372	7/8"	6-1/2"
21-373	7/8"	7"
21-374	7/8"	8"

CODIGO	DIAMETRO	LARGO
21-375	1"	3-1/2"
21-376	1"	4"
21-377	1"	4-1/2"
21-378	1"	5"
21-379	1"	5-1/2"
21-380	1"	6"
21-381	1"	6-1/2"
21-382	1"	7"
21-383	1"	7-1/2"
21-384	1"	8"
21-385	1"	9"
21-386	1"	10"

CODIGO	DIAMETRO	LARGO
21-387	1-1/8"	4"
21-388	1-1/8"	4-1/2"
21-389	1-1/8"	5"
21-390	1-1/8"	5-1/2"
21-391	1-1/8"	6"
21-392	1-1/8"	6-1/2"
21-393	1-1/8"	7"
21-394	1-1/8"	7-1/2"
21-395	1-1/8"	8"
21-396	1-1/8"	9"



PERNO DE ARADO TIPO CHARRO

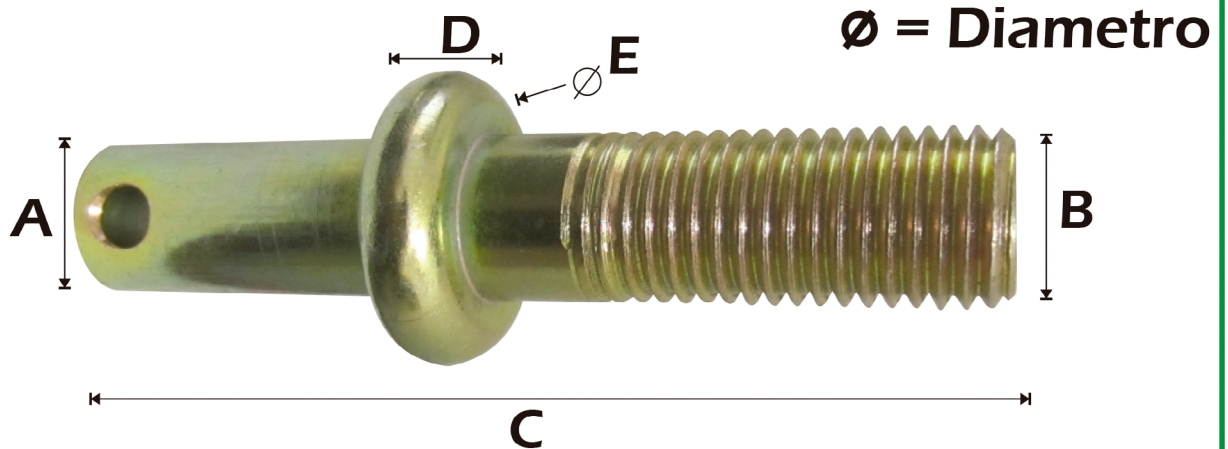

CODIGO	(A)	(B)	(C)	(D)	(E)
21-400	3/4"	3/4"	3"	1/4"	1-1/4"
21-401	3/4"	3/4"	4"	1/4"	1-1/4"
21-402	3/4"	3/4"	6"	1/4"	1-1/4"
21-403	3/4"	3/4"	7"	1/4"	1-1/4"

CODIGO	(A)	(B)	(C)	(D)	(E)
21-404	7/8"	3/4"	3"	5/16"	1-3/8"

CODIGO	(A)	(B)	(C)	(D)	(E)
21-405	7/8"	7/8"	5"	5/16"	1-3/8"
21-406	7/8"	7/8"	5-1/2"	5/16"	1-3/8"
21-407	7/8"	7/8"	6"	5/16"	1-3/8"
21-408	7/8"	7/8"	7"	5/16"	1-3/8"

CODIGO	(A)	(B)	(C)	(D)	(E)
21-409	1"	3/4"	5"	3/8"	1-1/2"
21-410	1"	3/4"	6"	3/8"	1-1/2"
21-411	1"	3/4"	6-1/2"	3/8"	1-1/2"
21-412	1"	3/4"	7"	3/8"	1-1/2"

CODIGO	(A)	(B)	(C)	(D)	(E)
21-413	1"	7/8"	5"	3/8"	1-1/2"
21-414	1"	7/8"	5-1/2"	3/8"	1-1/2"
21-415	1"	7/8"	6"	3/8"	1-1/2"
21-416	1"	7/8"	6-1/2"	3/8"	1-1/2"
21-417	1"	7/8"	7"	3/8"	1-1/2"

CODIGO	(A)	(B)	(C)	(D)	(E)
21-418	1"	1"	5"	3/8"	1-1/2"
21-419	1"	1"	5-1/2"	3/8"	1-1/2"
21-420	1"	1"	6"	3/8"	1-1/2"
21-421	1"	1"	6-1/2"	3/8"	1-1/2"
21-422	1"	1"	7"	3/8"	1-1/2"

CODIGO	(A)	(B)	(C)	(D)	(E)
21-423	1-1/8"	7/8"	4-1/2"	3/8"	1-1/2"
21-424	1-1/8"	7/8"	5"	3/8"	1-1/2"
21-425	1-1/8"	7/8"	5-1/2"	3/8"	1-1/2"
21-426	1-1/8"	7/8"	6"	3/8"	1-1/2"
21-427	1-1/8"	7/8"	6-1/2"	3/8"	1-1/2"
21-428	1-1/8"	7/8"	7"	3/8"	1-1/2"

CODIGO	(A)	(B)	(C)	(D)	(E)
21-429	1-1/8"	1"	5"	3/8"	1-1/2"
21-430	1-1/8"	1"	5-1/2"	3/8"	1-1/2"
21-431	1-1/8"	1"	6"	3/8"	1-1/2"
21-432	1-1/8"	1"	6-1/2"	3/8"	1-1/2"
21-433	1-1/8"	1"	7"	3/8"	1-1/2"

CODIGO	(A)	(B)	(C)	(D)	(E)
21-434	1-1/8"	1-1/8"	5"	3/8"	1-1/2"
21-435	1-1/8"	1-1/8"	5-1/2"	3/8"	1-1/2"
21-436	1-1/8"	1-1/8"	6"	3/8"	1-1/2"
21-437	1-1/8"	1-1/8"	6-1/2"	3/8"	1-1/2"
21-438	1-1/8"	1-1/8"	7"	3/8"	1-1/2"
21-439	1-1/8"	1-1/8"	8"	3/8"	1-1/2"

El largo del tornillo se mide desde la punta hasta el centro de la armella

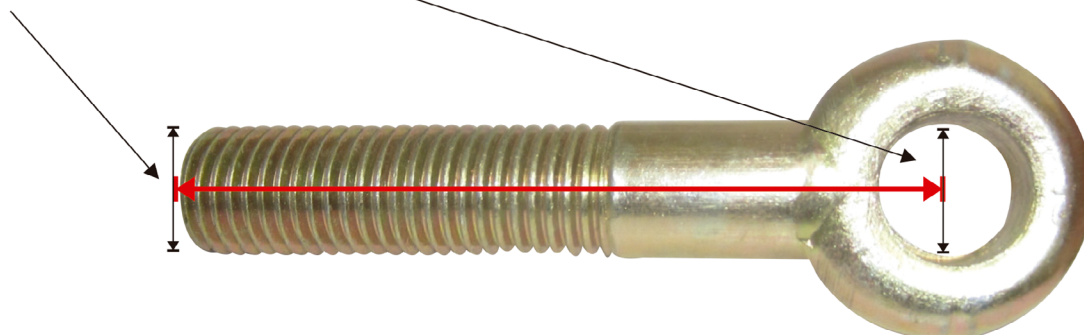

CODIGO	MEDIDA	LARGO
21-443	3/8"-R	2"

CODIGO	MEDIDA	LARGO
21-444	1/2-13"-R	2-1/2"













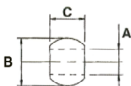

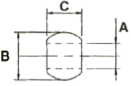



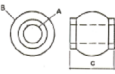

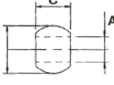

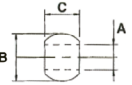

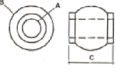
CODIGO	MEDIDA	LARGO
21-074-R	3/4-10"-R	2-1/2"
21-074-L	3/4-10"-L	2-1/2"
21-447	3/4-10"-R	3"
21-448	3/4-10"-L	3"
21-449	3/4-10"-R	4"
21-450	3/4-10"-L	4"
21-451	3/4-10"-R	4-1/2"
21-452	3/4-10"-R	5"
21-453	3/4-10"-R	6"
21-454	3/4-10"-R	7"
21-455	3/4-10"-R	7-1/2"

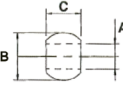
CODIGO	MEDIDA	LARGO
21-456	7/8-9"-R	2-1/2"
21-457	7/8-9"-L	2-1-2"
21-458	7/8-9"-R	3"
21-460	7/8-9"-R	3-1/2"
21-461	7/8-9"-L	3-1/2"
21-462	7/8-9"-R	4"
21-463	7/8-9"-L	4"
21-464	7/8-9"-R	4-1/2"
21-465	7/8-9"-R	5"
21-466	7/8-9"-R	5-1/2"
21-467	7/8-9"-R	6"
21-468	7/8-9"-R	6-1/2"
21-469	7/8-9"-R	7"
21-470	7/8-9"-R	8"

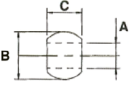
CODIGO	MEDIDA	LARGO
21-471	1-8"-R	3-1/2"
21-472	1-8"-R	4"
21-473	1-8"-R	4-1/2"
21-474	1-8"-R	5"
21-475	1-8"-R	5-1/2"
21-476	1-8"-R	6"
21-477	1-8"-L	6-1/2"
21-478	1-8"-R	6-1/2"
21-479	1-8"-R	7"
21-480	1-8"-R	8"
21-481	1-8"-R	10"

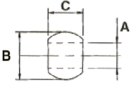
Precio pendiente

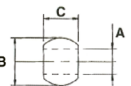

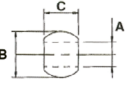
<p>21-025</p>    <p>DESCRIPCION: BOLAS O CUENCA AGRICOLAS</p> <p>INTERIOR (A) 1-1/8" EXTERIOR (B) 2-3/16" ALTURA (C) 1-3/4"</p>	<p>21-025-A</p>    <p>DESCRIPCION: BOLAS O CUENCA AGRICOLAS</p> <p>INTERIOR (A) 1-1/8" EXTERIOR (B) 2" ALTURA (C) 1-3/8"</p>	<p>21-026</p>   <p>Muesca 3/8</p> <p>DESCRIPCION: BOLA CON CUENCA PARA MASSEY FERGUSON</p> <p>INTERIOR (A) 1-1/8" EXTERIOR (B) 2-3/16" ALTURA (C) 1-3/4"</p>
<p>21-027</p>    <p>DESCRIPCION: BOLA DE TIRANTE DE 3er. PUNTO JHON DEERE</p> <p>INTERIOR (A) 1" EXTERIOR (B) 2" ALTURA (C) 2"</p>	<p>21-045</p>   <p>DESCRIPCION: BOLA DE TIRANTE DE 3er. PUNTO JHON DEERE</p> <p>INTERIOR (A) 7/8" EXTERIOR (B) 1-3/4" ALTURA (C) 1-1/4"</p>	<p>21-046</p>   <p>DESCRIPCION: BOLA PARA BRAZO INFERIOR DE ENGANCHI</p> <p>INTERIOR (A) 1" EXTERIOR (B) 2" ALTURA (C) 1-1/2"</p>
<p>21-047</p>   <p>DESCRIPCION: BOLA PARA BRAZO INFERIOR DE ENGANCH</p> <p>INTERIOR (A) 1-1/8" EXTERIOR (B) 2" ALTURA (C) 2-1/8"</p>	<p>21-048</p>   <p>DESCRIPCION: BOLA PARA BRAZO INFERIOR DE ENGANCH</p> <p>INTERIOR (A) 3/4" EXTERIOR (B) 1-7/8" ALTURA (C) 1-3/8"</p>	<p>21-049</p>   <p>DESCRIPCION: BOLA PARA BRAZO INFERIOR DE ENGANCH</p> <p>INTERIOR (A) 7/8" EXTERIOR (B) 2" ALTURA (C) 1-3/8"</p>
<p>21-050</p>   <p>DESCRIPCION: BOLA PARA BRAZO INFERIOR DE ENGANCH</p> <p>INTERIOR (A) 7/8" EXTERIOR (B) 2-3/16" ALTURA (C) 1-3/8"</p>	<p>21-051</p>   <p>DESCRIPCION: BOLA PARA BRAZO INFERIOR DE ENGANCH</p> <p>INTERIOR (A) 1-1/8" EXTERIOR (B) 2-3/16" ALTURA (C) 1-3/8"</p>	<p>21-052</p>   <p>DESCRIPCION: BOLA PARA BRAZO INFERIOR DE ENGANCH</p> <p>INTERIOR 1 (A) 7/8" EXTERIOR 2 (A) 1-1/8" EXTERIOR (B) 2-3/16" ALTURA (C) 1-3/4"</p>

Precio pendiente

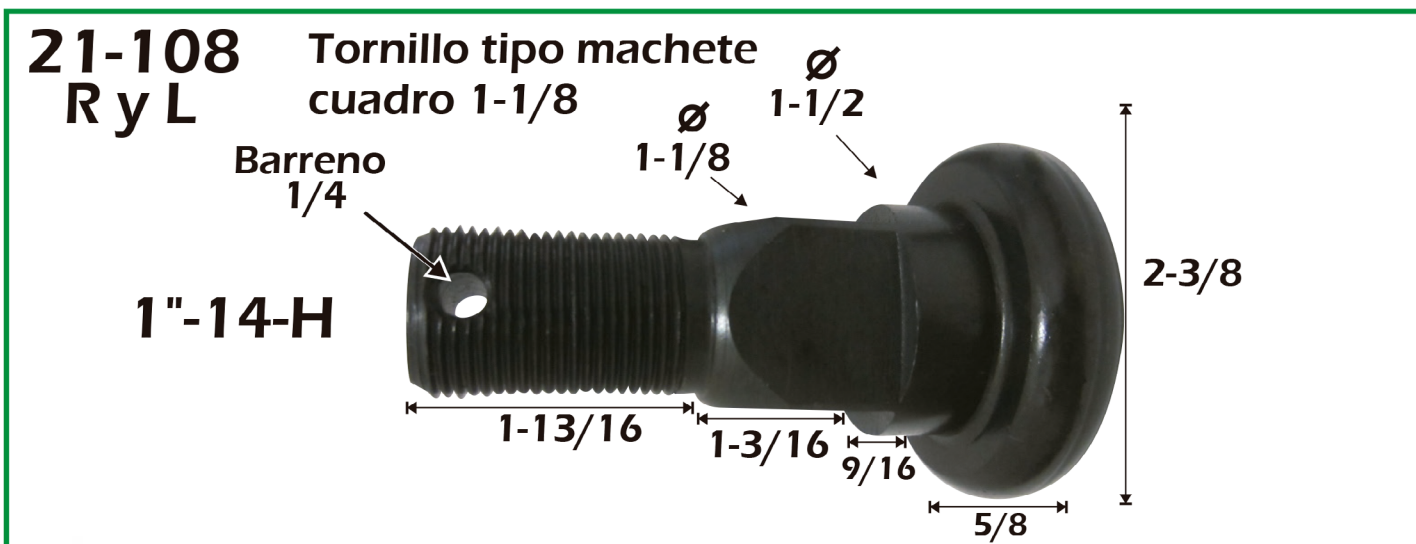
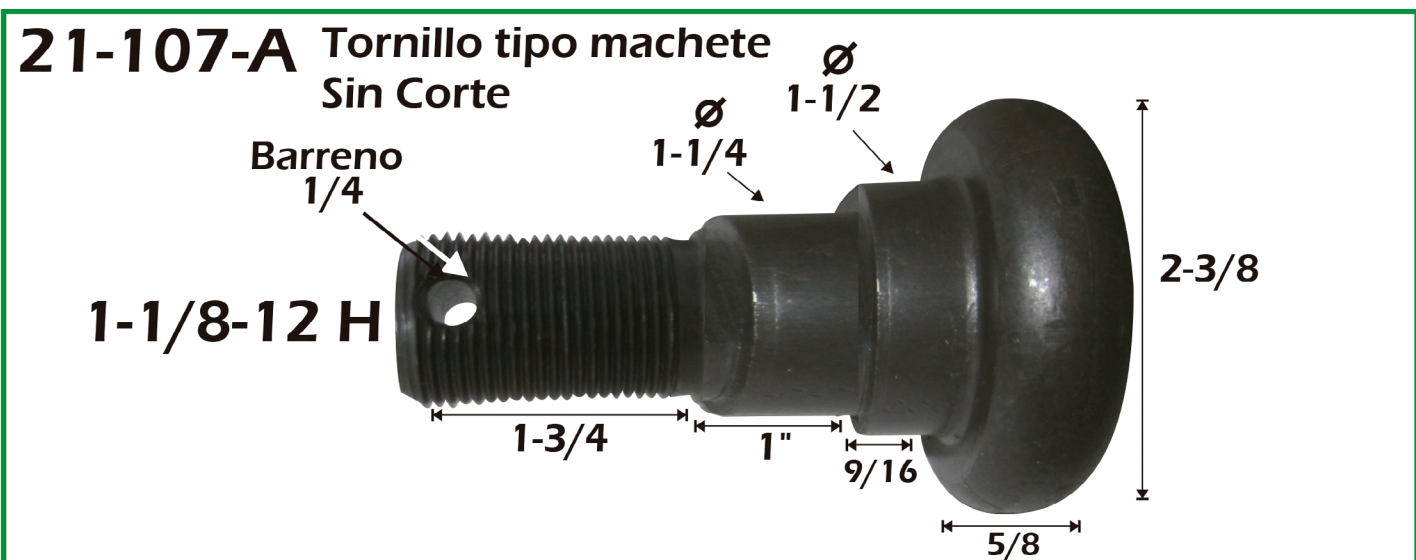
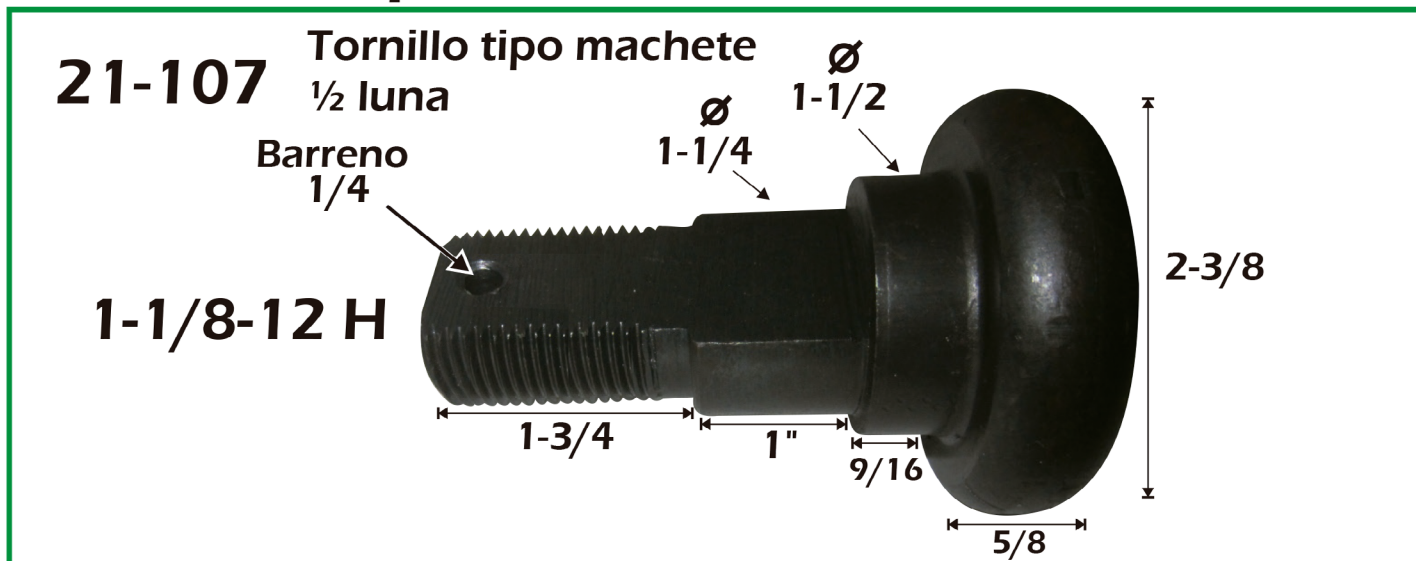

21-108-A
R y L

Tornillo tipo machete
cuadro 1-1/16

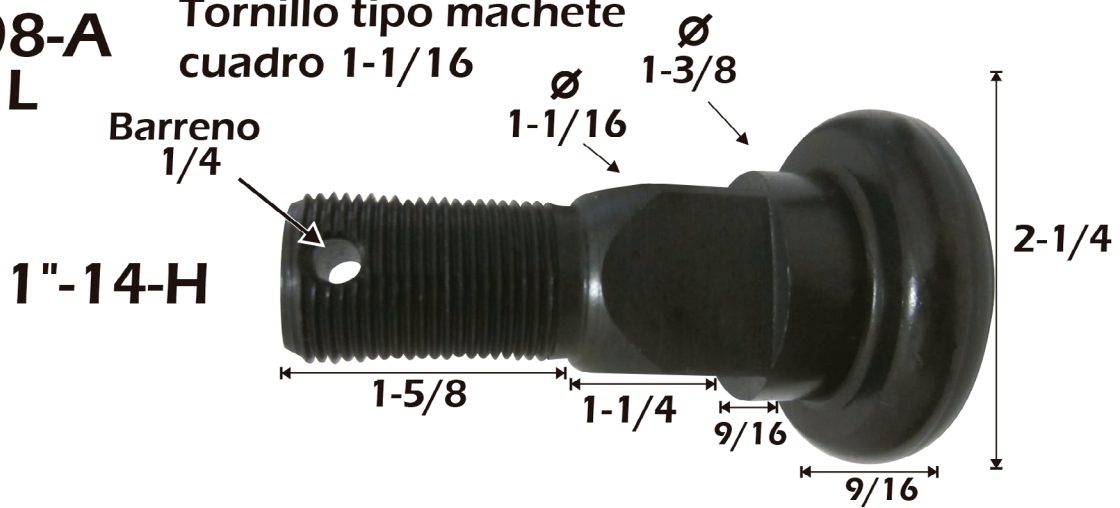

21-109

Tornillo tipo machete 3/4
redondo 1-1/4

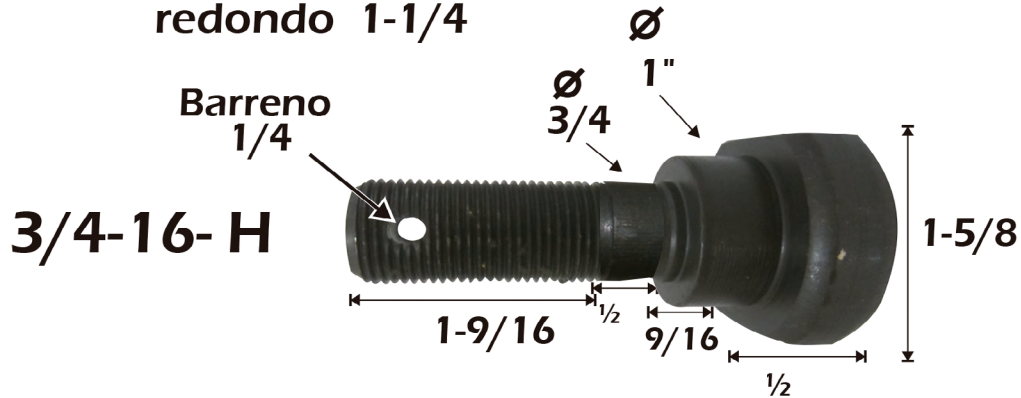

21-110

Tornillo tipo machete 7/8
redondo 1-1/4

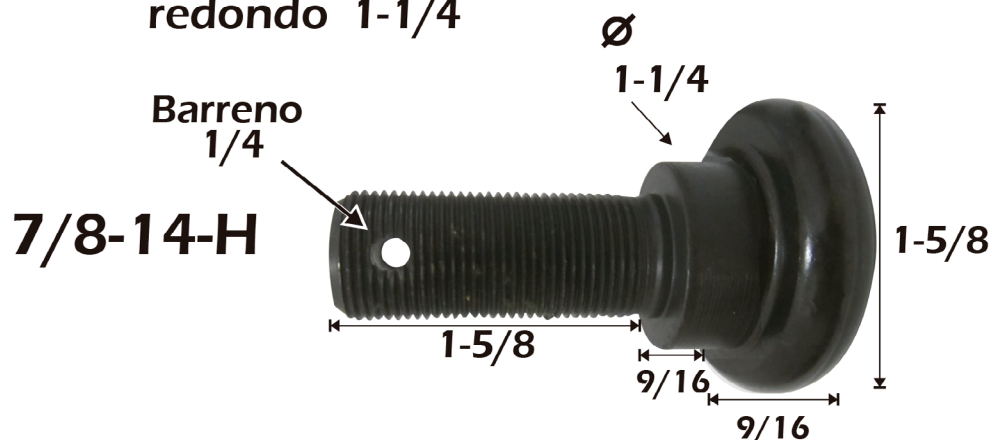

21-111 Tornillo tipo machete 1" redondo 1-1/2
R y L

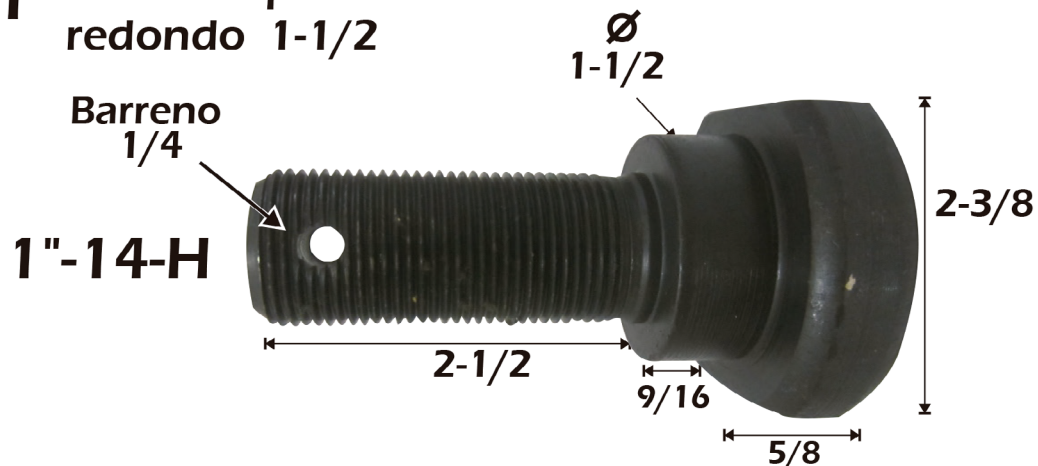

21-111-A Tornillo tipo machete 1" redondo 1-3/8
R y L

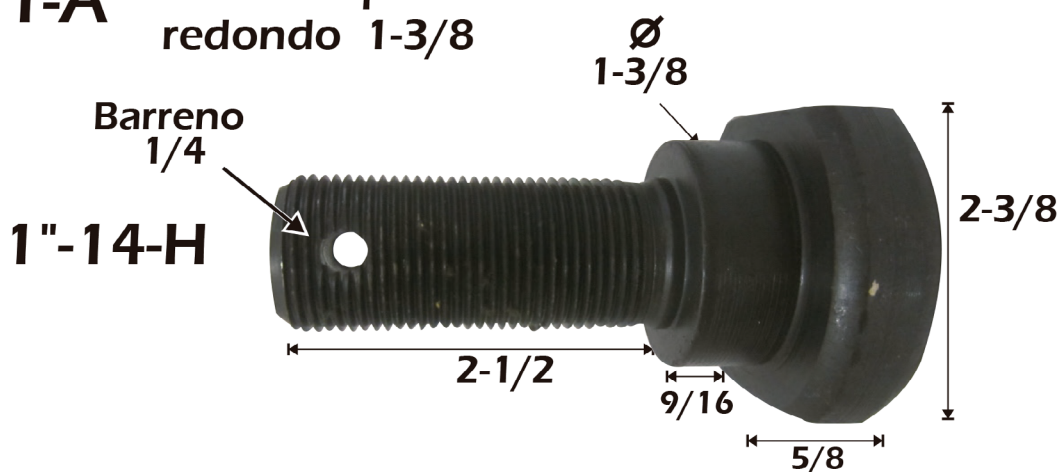

Barras 3er. Punto para Tractores (Barra De Tiro Oscilante)

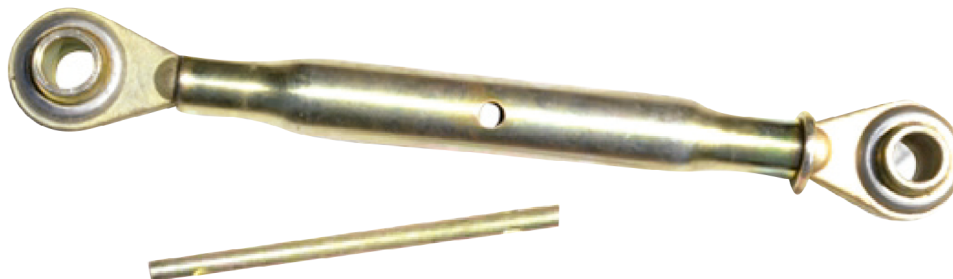

21-171	Barras 3er. Punto corta para Tractores (Barra De Tiro Oscilante)
21-172	Barras 3er. Punto larga para Tractores (Barra De Tiro Oscilante)

Crucetas Agrícolas



CODIGO	DESCRIPCION
21-5-170X-KYS	CRUCETA CARDAN
21-5-200	CRUCETA AGRICOLA 5-200
21-35-N	CRUCETA AGRICOLA 35-N
21-X438	CRUCETA MERCEDEZ BENZ 438
21-X469	CRUCETA MIXTA 469
21-X515	CRUCETA MIXTA 515

Yugo redondo para Cruceta 35

CODIGO
21-137



H-501

Yugo Cuadrado para Cruceta 35

CODIGO
21-138



H-502

Yugo Estriado con Enganche para Cruceta 35

CODIGO
21-140



H-504

Yugo redondo para Cruceta 35 Flange

CODIGO
21-141



H-508

Pernos P/Eje Delantero Massey Ferguson

Codigo	Descripcion
21-491	1-7/8x11-1/4x5/16 PERNO P/EJE DEL. MASSEY FERGUSON
21-490	1-7/8x10-1/4x5/16 PERNO P/EJE DEL. MASSEY FERGUSON

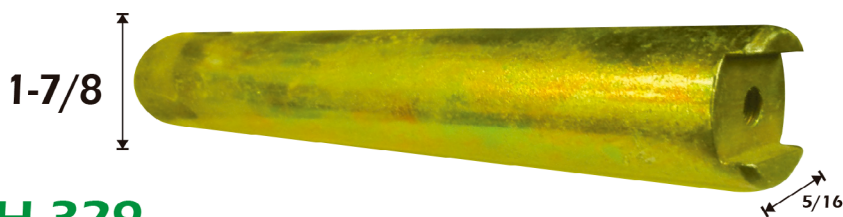

H-329

Seguro para Eje Delantero

CODIGO
21-250

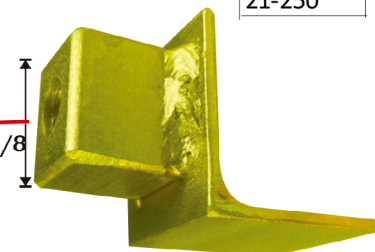

Perno P/Eje Delantero Cabeza Hexagonal

CODIGO
21-060

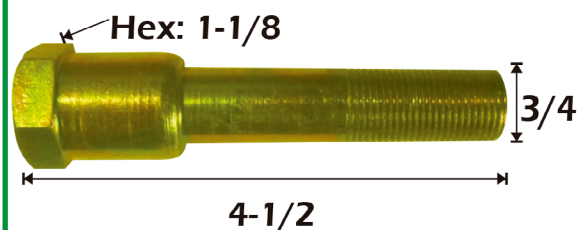

21-060

H-426

CODIGO
21-495

Tornillo fusible

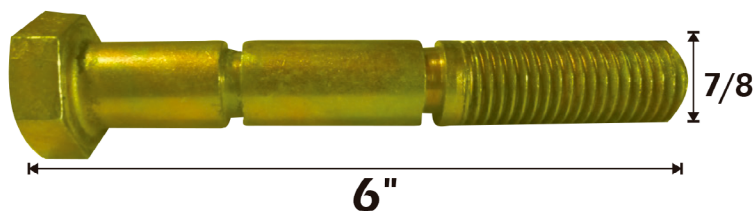

H-316

CODIGO
21-496

PERNO DE ENGANCHE BARRA AUX P/FORD

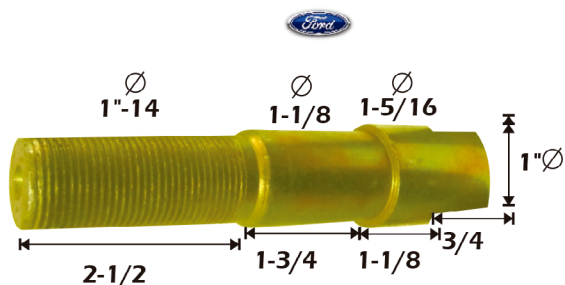

CODIGO
21-497

PERNO DE ENGANCHE BARRA AUX ESC/FORD

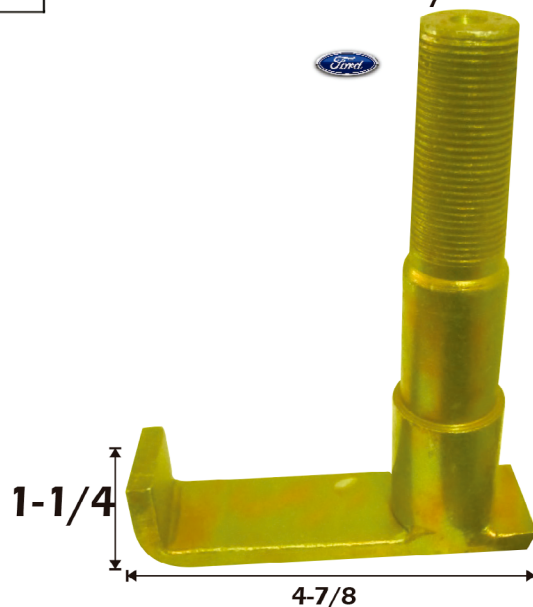

Perno liso sin cabeza P/Perno Timon

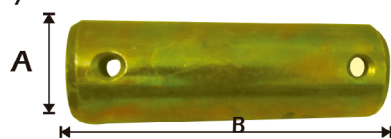

CODIGO	(A)	(B)
PLT-78x3	7/8	3"
PLT-78x314	7/8	3-1/4

Precio pendiente

PERNO DE ARADO TIPO CHARRO

CODIGO
21-498

Perno Del Brazo estabilizador

CODIGO
21-499

Perno Del Brazo estabilizador

CODIGO
21-500

Perno Del Brazo estabilizador

Perno Liso Tipo Bala

COD	MEDIDA	LARGO
21-251	1/2"	2-1/2"
21-252	5/8"	2-1/2"
21-253	3/4"	2-1/2"
21-254	1"	4-1/2"
21-255	1"	5-1/4"

CODIGO
21-440

Perno para Desvaradora Jhon deere W46503

CODIGO
21-542

Perno para Jhon deere W46503

Precio pendiente

PERNO DE ARADO TIPO CHARRO

COD
21-064

**Perno del eje delantero
C/Ceja Ford 5000**

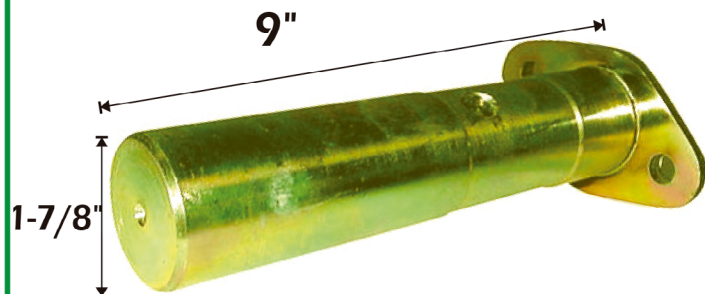

COD
21-067

**Perno Cárter para
Ford 5000**



COD
21-540

PERNO P/SUBSUELO JOHN DEERE

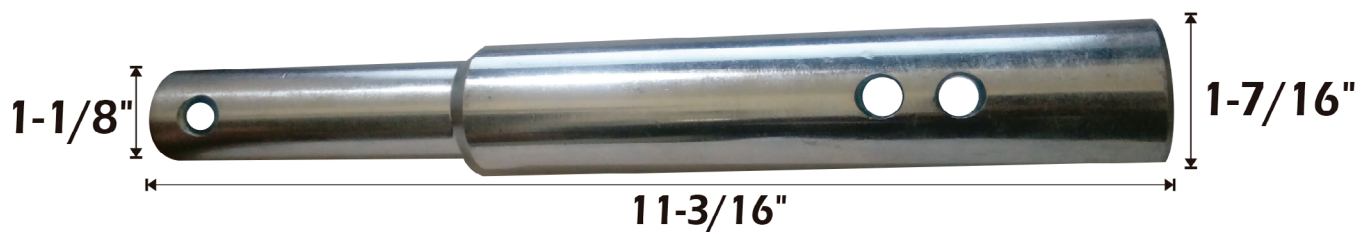

Bolas de tirón Agrícolas



COD	BOLA	MEDIDA	L. Espiga
21-210	2"	1-1/4-12"	2-1/2"
21-211	2-5/16"	1-1/4-12"	2-1/2"

ROSCA FINA

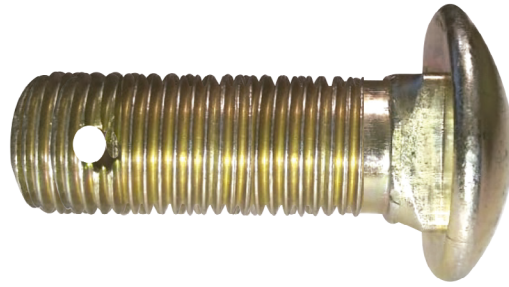

CODIGO	MEDIDA	LARGO
21-501	5/8"	3-1/2"
21-502	5/8"	4"
21-503	5/8"	4-1/2"
21-504	5/8"	5"

CODIGO	MEDIDA	LARGO
21-505	7/8"	2-1/2"

CODIGO	MEDIDA	LARGO
21-506	1"	2-1/4"
21-507	1"	2-1/2"
21-508	1"	3"
21-509	1"	12"

ROSCA ESTANDAR

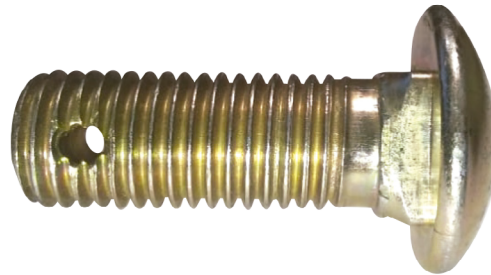

CODIGO	MEDIDA	LARGO
21-510	5/8"	3"
21-511	5/8"	3-1/2"
21-512	5/8"	4"
21-513	5/8"	4-1/2"
21-514	5/8"	5"
21-515	5/8"	7"

CODIGO	MEDIDA	LARGO
21-516	3/4"	4"
21-517	3/4"	4-1/2"
21-518	3/4"	5"
21-519	3/4"	6"
21-520	3/4"	6-1/2"
21-521	3/4"	7"

CODIGO	MEDIDA	LARGO
21-522	7/8"	2"
21-523	7/8"	2-1/2"
21-524	7/8"	2-5/8"
21-525	7/8"	3"
21-526	7/8"	3-1/2"
21-527	7/8"	4"
21-528	7/8"	5"
21-529	7/8"	8"
21-530	7/8"	9"
21-531	7/8"	10"

CODIGO	MEDIDA	LARGO
21-532	1"	2"
21-533	1"	2-1/4"
21-534	1"	2-5/8"
21-535	1"	3"
21-536	1"	12"

Precio pendiente

Tornillos Cabeza cuadrada



CODIGO	MEDIDA	LARGO
21-175	1/2"	2"
21-178	1/2"	2-1/2"
21-176	1/2"	3"
21-177	1/2"	3-1/2"
21-147	1/2"	4"
21-148	1/2"	4-1/2"
21-149	1/2"	5"

CODIGO	MEDIDA	LARGO
21-229	3/4"	2-1/2"
21-165	3/4"	2-3/4"
21-164	3/4"	3"
21-164-A	3/4"	3-1/2"
21-185	3/4"	4"
21-185-A	3/4"	4-1/2"
21-230	3/4"	5"
21-231	3/4"	5-1/2"
21-231-A	3/4"	6"

CODIGO	MEDIDA	LARGO
21-099	5/8"	2-1/2"
21-099-A	5/8"	2"
21-100	5/8"	3"
21-101	5/8"	3-1/2"
21-102	5/8"	4"
21-146	5/8"	4-1/2"
21-227	5/8"	5-1/2"
21-228	5/8"	6"
21-232	5/8"	5"
21-235	5/8"	2"
21-236	5/8"	7"

Birlos Conicos Agrícolas

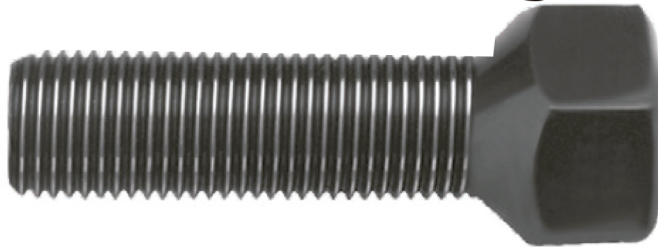

Finos

CODIGO	MEDIDA	LARGO
27-001	1/2"-20	1"
27-026	1/2"-20	1-1/4"
27-002	1/2"-20	1-1/2"
27-003	1/2"-20	1-3/4"
27-004	1/2"-20	2"
27-005	1/2"-20	2-1/4"
27-006	1/2"-20	2-1/2"
27-048	1/2"-20	3"

CODIGO	MEDIDA	LARGO
27-007	9/16"-18	1"
27-020	9/16"-18	1-1/4"
27-008	9/16"-18	1-1/2"
27-009	9/16"-18	1-3/4"
27-010	9/16"-18	2"
27-011	9/16"-18	2-1/4"
27-012	9/16"-18	2-1/2"
27-019	9/16"-18	3"

CODIGO	MEDIDA	LARGO
27-021	5/8"-18	1-1/4"
27-028	5/8"-18	1-1/2"
27-013	5/8"-18	2"
27-014	5/8"-18	2-1/2"
27-031	5/8"-18	3"

CODIGO	MEDIDA	LARGO
27-032-A	3/4"-16	1-1/2"
27-032	3/4"-16	2"
27-017	3/4"-16	2-1/2"
27-018	3/4"-16	3"
27-049	3/4"-16	3-1/4"

Estandar

CODIGO	MEDIDA	LARGO
27-022	9/16"-12	1-1/2"
27-023	9/16"-12	2"
27-024	9/16"-12	2-1/2"
27-025	9/16"-12	3"

CODIGO	MEDIDA	LARGO
27-028-A	5/8"-11	1-1/2"
27-015	5/8"-11	2"
27-016	5/8"-11	2-1/2"
27-027	5/8"-11	3"
27-034	5/8"-11	3-1/2"

CODIGO	MEDIDA	LARGO
27-029-A	3/4"-10	1-1/2"
27-029	3/4"-10	2"
27-033	3/4"-10	2-1/2"
27-030	3/4"-10	3"

Precio pendiente

<p>77-119 BR80-039RP</p> <p>2.500" .862" (21.89 mm) 3/4"-16 .777" (19.74 mm)</p> <p>Jhon Deere 92</p> <p>Otros 1: 7000 A R Otros 2: 77-1119</p>	<p>77-310 BR80-011RP</p> <p>2.562" 1.062" (26.99 mm) 5/8"-18 .632" (16.05 mm)</p> <p>Internacional harvester</p> <p>Otros 1: 7310 R Otros 2: 77-310</p>
<p>77-009 BR80-009RP</p> <p>3" 1.460" (37.08 mm) 5/8"-18 .625" (15.88 mm)</p> <p>Ford 5000, Fordson</p> <p>Otros 2: 77-009</p>	<p>77-220 BR80-031RP</p> <p>2.562" 1.062" (26.97 mm) 5/8"-11 .632" (16.05 mm)</p> <p>Internacional harvester</p> <p>Otros 2: 77-220</p>
<p>77-010 BR80-002RP</p> <p>3.500" 1.460" (37.08 mm) 5/8"-18 .625" (15.88 mm)</p> <p>Ford 5000, Fordson</p> <p>Otros 1: 70009 A R Otros 2: 77-010</p>	<p>77-221 BR80-032RP</p> <p>3" 1.062" (26.97 mm) 5/8"-11 .632" (16.05 mm)</p> <p>Internacional harvester</p> <p>Otros 2: 77-221</p>
<p>77-103 BR80-010RP</p> <p>3" 1.875" (47.63 mm) 5/8"-18 .632" (16.05 mm)</p> <p>Massey Ferguson</p> <p>Otros 1: 7103 R Otros 2: 77-103</p>	<p>77-222 BR80-033RP</p> <p>3.500" 1.062" (26.97 mm) 5/8"-11 5 mm</p> <p>Internacional harvester</p> <p>Otros 2: 77-222</p>
<p>77-114 BR80-036RP</p> <p>3.500" 1.875" (47.63 mm) 5/8"-18 .632" (16.05 mm)</p> <p>Jhon Deere</p> <p>Otros 2: 77-114</p>	<p>77-223 BR80-012RP</p> <p>4" 2.390" (60.71 mm) 5/8"-11 .624" (15.85 mm)</p> <p>Jhon Deere</p> <p>Otros 2: 77-223</p>

Precio pendiente

<p>77-105</p> <p>Rueda Delantera Massey Ferguson 135</p>  <p>1/2"-20</p> <p>Otros 1: 7015R Otros 2: 77-105</p>	<p>BR80-027RP</p>  <p>5/8"-18</p> <p>Otros 1: 7015R Otros 2: 77-105</p>
<p>77-104 BR80-003RP</p> <p>Rueda Delantera Massey Ferguson 165 Ford 5000</p>  <p>1/2"-20</p> <p>Otros 1: 7104R Otros 2: 77-104</p>	<p>77-176 BR80-028RP</p> <p>Rueda Delantera Massey Ferguson, Jhon Deere</p>  <p>5/8"-18</p> <p>Otros 2: 77-176</p>
<p>77-002 BR80-004RP</p> <p>Rueda Delantera Ford 5000, Fordson</p>  <p>1/2"-20</p> <p>Otros 1: 7002R Otros 2: 77-002</p>	<p>77-000 BR80-007RP</p> <p>Rueda Delantera Ford 5000, Fordson</p>  <p>3/4"-16</p> <p>Otros 1: 7000R Otros 2: 77-000</p>
<p>77-001 BR80-005RP</p> <p>Rueda Delantera Massey Ferguson 165 Ford 5000</p>  <p>1/2"-20</p> <p>Otros 1: 7001R Otros 2: 77-001</p>	<p>77-100 BR80-008RP</p> <p>Jhon Deere 92</p>  <p>3/4"-16</p> <p>Otros 1: 7000 E R Otros 2: 77-100</p>
<p>77-111 BR80-006RP</p> <p>Rueda Delantera Massey Ferguson 65 y 165</p>  <p>5/8"-18</p> <p>Otros 1: 7111R Otros 2: 77-111</p>	<p>77-012 BR80-029RP</p> <p>Rueda Delantera Massey Ferguson 65 y 165</p>  <p>3/4"-16</p> <p>Otros 2: 77-012</p>

Precio pendiente

<p>77-224 BR80-034RP</p> <p>Jhon Deere</p> <p>Otros 2: 77-224</p>	<p>77-007 BR80-045RP</p> <p>Rastra de Tractor</p> <p>Otros 2: 77-007</p>
<p>29-013 BR80-013RP</p> <p>Massey Ferguson</p> <p>Otros 2: 29-013</p>	<p>BR80-015RP Massey Ferguson 560</p> <p>Otros 2: 29-013</p>
<p>77-117 BR80-037RP</p> <p>Massey Ferguson 460</p> <p>Otros 2: 77-117</p>	<p>BR80-035RP Jhon Deere</p> <p>Otros 2: 77-117</p>
<p>BR80-038RP Massey Ferguson 460</p> <p>Otros 2: 77-117</p>	<p>PA00-2000P UNIVERSAL</p> <p>Otros 2: 77-117</p>
<p>77-011 BR80-014RP</p> <p>UNIVERSAL</p> <p>Otros 2: 77-011</p>	<p>PA00-2010P UNIVERSAL</p> <p>Otros 2: 77-011</p>

Precio pendiente



CODIGO	DESCRIPCION
197-3	3" ESPESOR .083 X 5 MTS LARGO TUBO VERDE FLECHA CARDAN
197-312-R	3-1/2" ESPESOR .095 X 5 MTS LARGO TUBO AZUL FLECHA CARDAN
197-412	4-1/2" ESPESOR .134 X 5 MTS LARGO TUBO ROSA FLECHA CARDAN
197-4-L	4" ESPESOR .083 X 5 MTS LARGO TUBO NEGRO FLECHA CARDAN
197-4-R	4" ESPESOR .134 X 5 MTS LARGO TUBO ROJO FLECHA CARDAN

DEL EJE CARDAN

MONTAJE CORRECTA



Precio pendiente

TIPO "A"

CODIGO	A	B	C
21-200	5/8"	3-1/4"	7-1/2"
21-201	3/4"	3-1/4"	7-1/4"
21-202	7/8"	3-1/4"	7-1/4"
21-203	1"	3-1/4"	7-1/4"

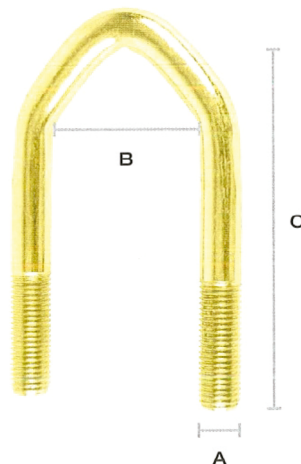

TIPO "B"

CODIGO	A	B	C
21-204	7/8"	4"	6-1/2"

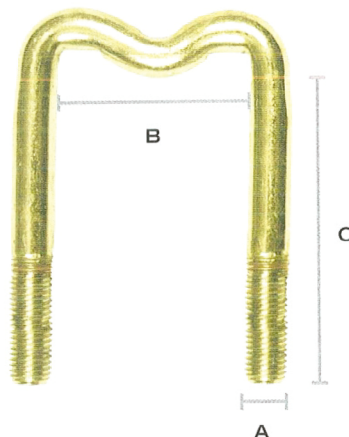

TIPO "C"

CODIGO	A	B	C
21-205	5/8"	5-1/2"	8"
21-206	5/8"	6-1/2"	8"
21-207	5/8"	4"	6"
21-208	1"	4"	8"

